

Studio Bifold Full Size

Manufactured by



290 DAIRY PAK RD. • ATHENS, GA 30607 • 800-543-3393

PARTS LIST

K-1	BACK RAIL	2	H-10	WRENCH		1
K-2	SEAT RAIL	2	H-13	3 1/2" BOLT		2
K-4	PROP	2	H-18	2 1/2" BOLT		4
K-5	PROP CONNECTOR	1	H-14	WING NUT		6
K-6	BACK LEG (Left and Right)	2	H-6	WASHER		6
K-7	SEAT LEG	2	H-4	2" SCREW		12
S-2	SEAT	1	H-15	#8 WOOD SCREW		4
S-1	BACK	1	H-16	WHEEL		2

1 PARTS

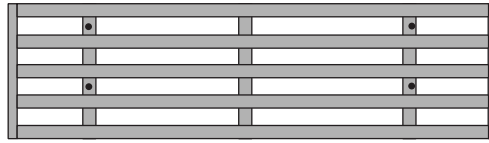

S-1 BACK (1)

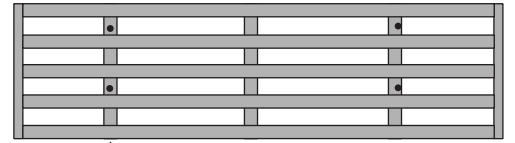

Supports are closer together on the seat

S-2 SEAT (1)



K-6R BACK LEG (Left)



K-6L BACK LEG (Right)



K-7 SEAT LEG (2)



K-4 PROP (2)



K-2 SEAT RAIL (2)



K-1 BACK RAIL (2)



K-5 PROP CONNECTOR (1)

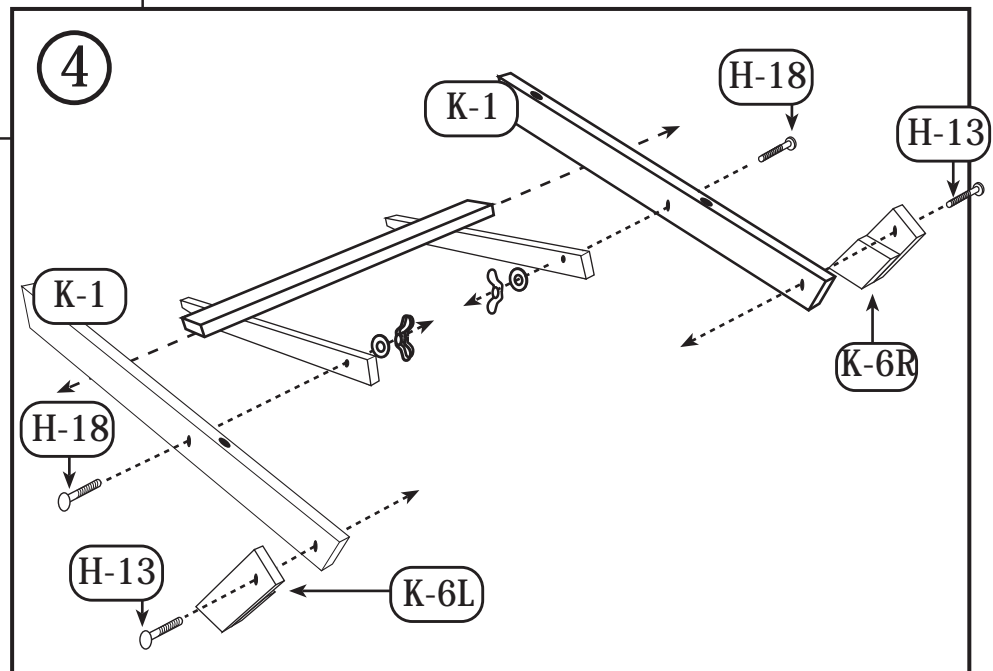
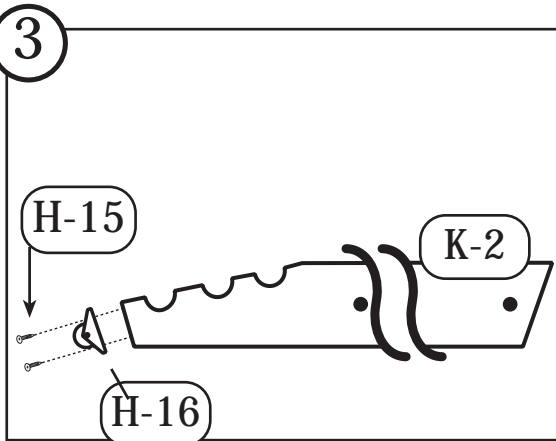
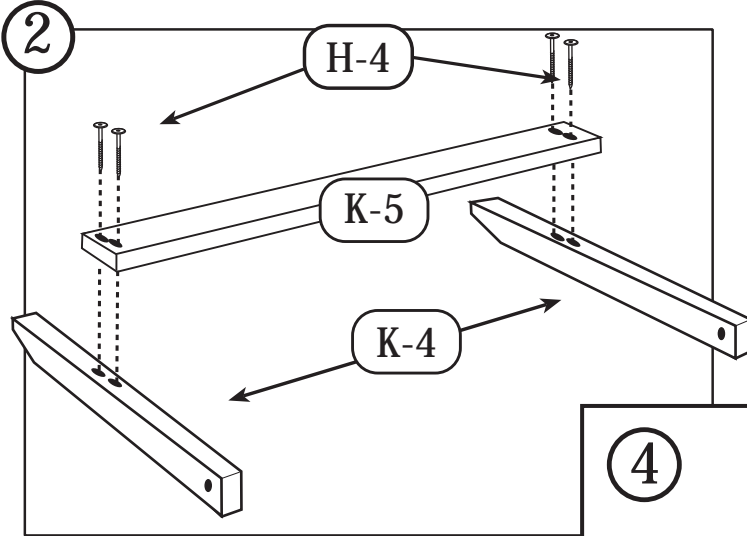

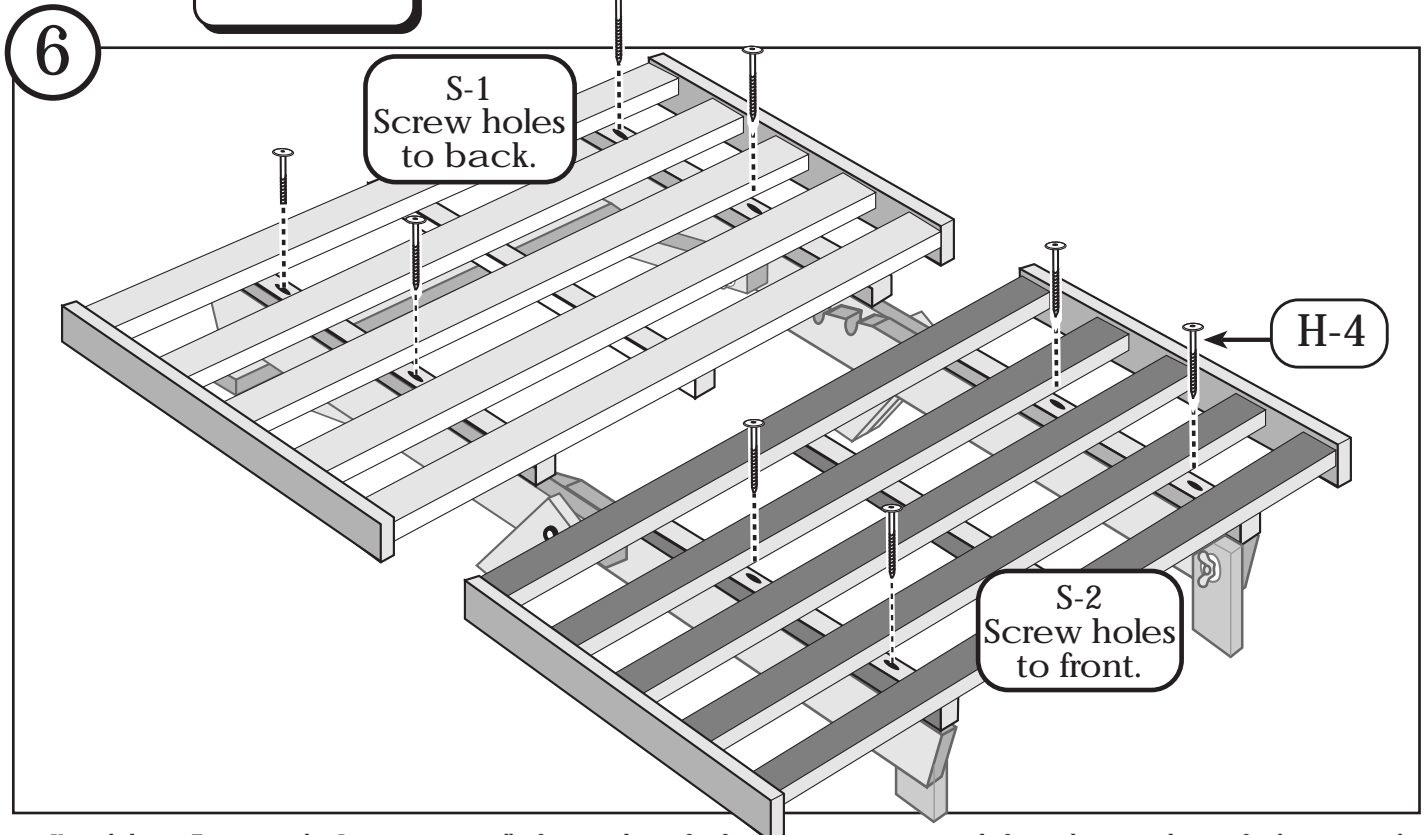
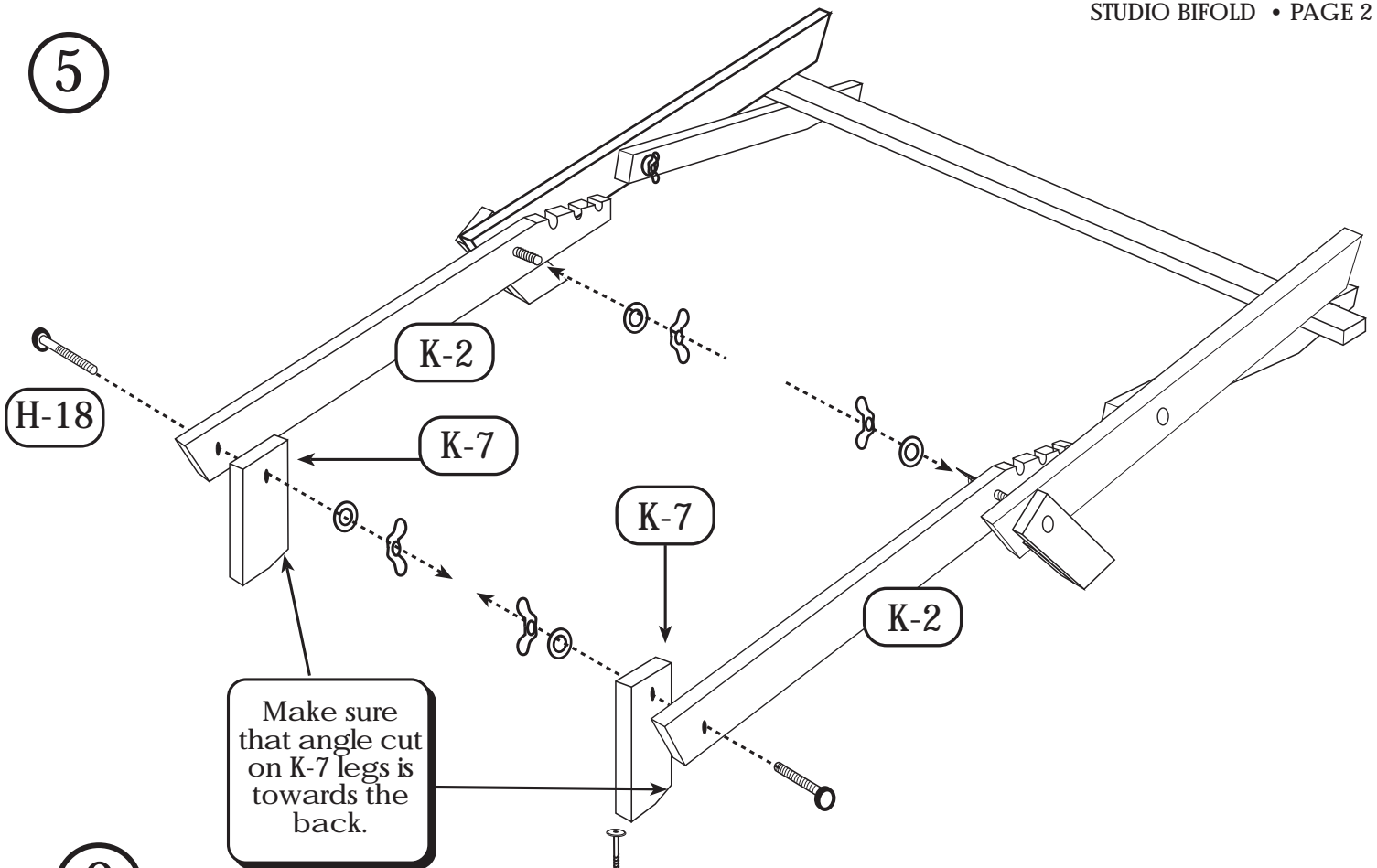

Knockdown Frameworks, Inc. warrants all of its products for five years against any defects that are due to faulty materials or workmanship. We will promptly correct such defects by repair or replacement, at our option, without charge. This warranty covers product defects only and will expire five years after date of purchase by the original consumer purchaser, with proof of purchase required.

This warranty does not apply to damage caused by and resulting from misuse, neglect, accident, or improper operation, maintenance, storage, transportation, or handling of the product. This warranty is for the original consumer purchaser for residential use only and does not apply if the product is used in any commercial application (such as rental property). This warranty does not cover any incidental or consequential damages. If you feel that you have a claim under this warranty, please contact the store from which it was purchased. If this is not possible, call 800-543-3393 for advice on handling your claim.